

# 600 ECO

405/505 ECO (600x575x296)

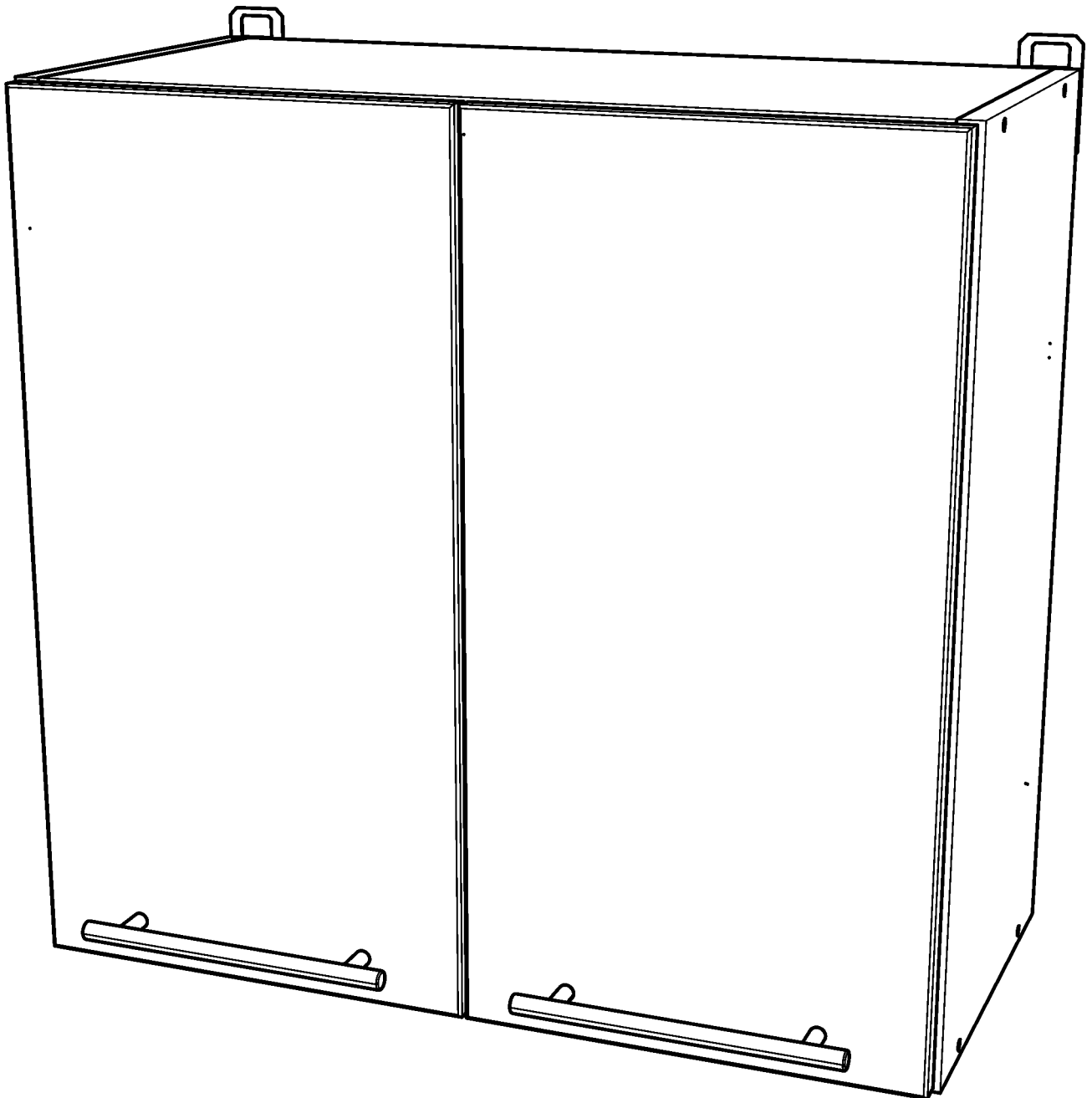

① 575x280-1

② 575x280-1

③ 568x280-2

④ 295x570-2

⑤ 570x298-2

⑥ 540mm-1

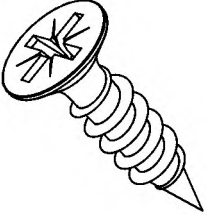
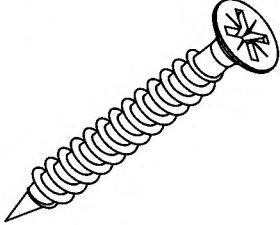
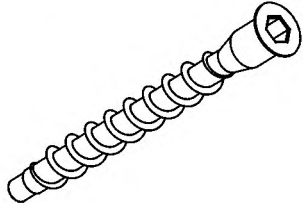
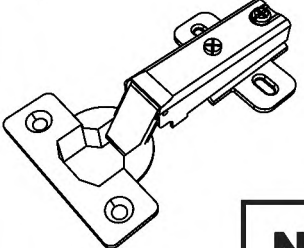
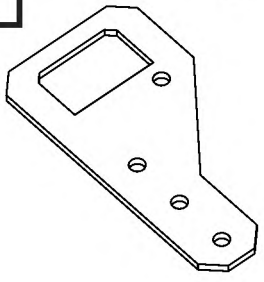
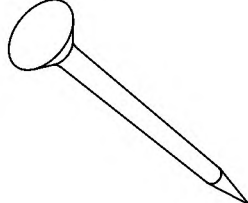
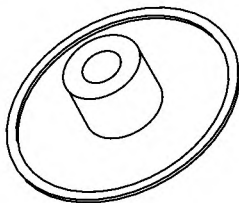
<p>1 18 x</p>  <p>3,5x16</p>	<p>2 12 x</p>  <p>4x30</p>	<p>3 8 x</p> 	<p>4 4 x</p>  <p>N</p>
<p>5 2 x</p> 	<p>6 30 x</p> 	<p>7 8 x</p> 	<p>8 2 x</p> 